

|           |       |
|-----------|-------|
| PROJECT   | _____ |
| TYPE      | _____ |
| SPECIFIER | _____ |
| QUANTITY  | _____ |
| DATE      | _____ |

## CENTRIQ 95 TRACK

### A3T013-

|             |             |                   |                    |                     |                      |                   |
|-------------|-------------|-------------------|--------------------|---------------------|----------------------|-------------------|
| base number | LED Dimming | Color Temperature | Finishes (Diamond) | Finishes (Triangle) | Track Adapter Finish | Reflector Options |
|-------------|-------------|-------------------|--------------------|---------------------|----------------------|-------------------|

- To build a product code in our configurator select the specify button on the base model # product page
- To build a manual product code on this datasheet choose from the options listed below in blue font and add the suffix to the base model #

#### GENERAL

Series: Centriq  
 Subseries: Centriq 95  
 Brand: Prolicht  
 Division: Architectural  
 Mounting Type: Track  
 Mounting Location: Ceiling  
 Subcategory: Spots

#### PHYSICAL

Shape: Cylinder  
 Diameter (mm): 95  
 Diameter (in): 3 3/4  
 Length (mm): 235  
 Length (in): 9 1/4  
 Height (mm): 150  
 Height (in): 5 7/8  
 Light Distribution: Adjustable / Direct  
 Weight (kg): 1.495  
 Weight (lbs): 3.3  
 Fixture Finish: SSR / BKV / CWI / CRY / HAB / UFT / ITA / RUA / FTG / MYG / LOD / PUS / FRO / FUP / KIA / POP / BLS / SPG / MEY / GOH / GUM / CHC / COM / ABZ / JAG / OBR / MOS / ROR  
 Fixture Material: Aluminum

#### ELECTRICAL

Lamp Type: LED (Zhaga Standard)  
 Input Wattage (W): 18  
 Total Output Wattage (W): 16.4  
 Dimming: Tri-Mode (Non-Dimming and Phase Dimming (120Vac only) and 0-10V Dimming)  
 Driver Included: Yes  
 Driver Location: Integrated  
 Driver Type: Constant Current - Universal  
 Driver Class: Class 2  
 Input Voltage (V): 120 - 277  
 Constant Current (MA): 500

#### LED

Number of LEDs: 1  
 Color Temperature (°K): 2700 / 3000 / 3500 / 4000  
 Max. Delivered Lumen (lm): 1567 / 1666 / 1719 / 1754  
 Nominal Lumen (lm): 2271 / 2414 / 2491 / 2542  
 CRI: >90 CRI  
 Lamp Life (hrs): 50000  
 Upon Request: Special Color Temperature Special Led

#### OPTICAL

Reflector: 18 / 26 / 40  
 Adjustability: Rotational 340°; Tilt 90°  
 Upon Request: Special Beam Angles

#### RATINGS AND CERTIFICATIONS

Certified By: Certified for North American Standards  
 IP rating: IP20



## CENTRIQ 95 TRACK

A3T013-

PROJECT \_\_\_\_\_

TYPE \_\_\_\_\_

SPECIFIER \_\_\_\_\_

QUANTITY \_\_\_\_\_

DATE \_\_\_\_\_



A

|           |  |
|-----------|--|
| PROJECT   |  |
| TYPE      |  |
| SPECIFIER |  |
| QUANTITY  |  |
| DATE      |  |

## CENTRIQ 95 TRACK

### A3T016-

|             |             |                   |                    |                     |                      |                   |
|-------------|-------------|-------------------|--------------------|---------------------|----------------------|-------------------|
| base number | LED Dimming | Color Temperature | Finishes (Diamond) | Finishes (Triangle) | Track Adapter Finish | Reflector Options |
|-------------|-------------|-------------------|--------------------|---------------------|----------------------|-------------------|

- To build a product code in our configurator select the specify button on the base model # product page
- To build a manual product code on this datasheet choose from the options listed below in blue font and add the suffix to the base model #

#### GENERAL

Series: Centriq  
 Subseries: Centriq 95  
 Brand: Prolicht  
 Division: Architectural  
 Mounting Type: Track  
 Mounting Location: Ceiling  
 Subcategory: Spots

#### PHYSICAL

Shape: Cylinder  
 Diameter (mm): 95  
 Diameter (in): 3 3/4  
 Length (mm): 235  
 Length (in): 9 1/4  
 Height (mm): 150  
 Height (in): 5 7/8  
 Light Distribution: Adjustable / Direct  
 Weight (kg): 1.495  
 Weight (lbs): 3.3  
 Fixture Finish: SSR / BKV / CWI / CRY / HAB / UFT / ITA / RUA / FTG / MYG / LOD / PUS / FRO / FUP / KIA / POP / BLS / SPG / MEY / GOH / GUM / CHC / COM / ABZ / JAG / OBR / MOS / ROR  
 Fixture Material: Aluminum

#### ELECTRICAL

Lamp Type: LED (Zhaga Standard)  
 Input Wattage (W): 26  
 Total Output Wattage (W): 23.6  
 Dimming: Tri-Mode (Non-Dimming and Phase Dimming (120Vac only) and 0-10V Dimming)  
 Driver Included: Yes  
 Driver Location: Integrated  
 Driver Type: Constant Current - Universal  
 Driver Class: Class 2  
 Input Voltage (V): 120 - 277  
 Constant Current (MA): 700

#### LED

Number of LEDs: 1  
 Color Temperature (°K): 2700 / 3000 / 3500 / 4000  
 Max. Delivered Lumen (lm): 2148 / 2289 / 2357 / 2405  
 Nominal Lumen (lm): 3113 / 3317 / 3416 / 3486  
 CRI: >90 CRI  
 Lamp Life (hrs): 50000  
 Upon Request: Special Color Temperature Special Led

#### OPTICAL

Reflector: 18 / 26 / 40  
 Adjustability: Rotational 340°; Tilt 90°  
 Upon Request: Special Beam Angles

#### RATINGS AND CERTIFICATIONS

Certified By: Certified for North American Standards  
 IP rating: IP20



## CENTRIQ 95 TRACK

A3T016-

|           |
|-----------|
| PROJECT   |
| TYPE      |
| SPECIFIER |
| QUANTITY  |
| DATE      |



A

|           |       |
|-----------|-------|
| PROJECT   | _____ |
| TYPE      | _____ |
| SPECIFIER | _____ |
| QUANTITY  | _____ |
| DATE      | _____ |

## CENTRIQ 95 TRACK

### A3T019-

|             |             |                   |                    |                     |                      |                   |
|-------------|-------------|-------------------|--------------------|---------------------|----------------------|-------------------|
| base number | LED Dimming | Color Temperature | Finishes (Diamond) | Finishes (Triangle) | Track Adapter Finish | Reflector Options |
|-------------|-------------|-------------------|--------------------|---------------------|----------------------|-------------------|

- To build a product code in our configurator select the specify button on the base model # product page
- To build a manual product code on this datasheet choose from the options listed below in blue font and add the suffix to the base model #

#### GENERAL

Series: Centriq  
 Subseries: Centriq 95  
 Brand: Prolicht  
 Division: Architectural  
 Mounting Type: Track  
 Mounting Location: Ceiling  
 Subcategory: Spots

#### PHYSICAL

Shape: Cylinder  
 Diameter (mm): 95  
 Diameter (in): 3 3/4  
 Length (mm): 235  
 Length (in): 9 1/4  
 Height (mm): 150  
 Height (in): 5 7/8  
 Light Distribution: Adjustable / Direct  
 Weight (kg): 1.495  
 Weight (lbs): 3.3  
 Fixture Finish: SSR / BKV / CWI / CRY / HAB / UFT / ITA / RUA / FTG / MYG / LOD / PUS / FRO / FUP / KIA / POP / BLS / SPG / MEY / GOH / GUM / CHC / COM / ABZ / JAG / OBR / MOS / ROR  
 Fixture Material: Aluminum

#### ELECTRICAL

Lamp Type: LED (Zhaga Standard)  
 Input Wattage (W): 34  
 Total Output Wattage (W): 30.9  
 Dimming: Tri-Mode (Non-Dimming and Phase Dimming (120Vac only) and 0-10V Dimming)  
 Driver Included: Yes  
 Driver Location: Integrated  
 Driver Type: Constant Current - Universal  
 Driver Class: Class 2  
 Input Voltage (V): 120 - 277  
 Constant Current (MA): 900

#### LED

Number of LEDs: 1  
 Color Temperature (°K): 2700 / 3000 / 3500 / 4000  
 Max. Delivered Lumen (lm): 2710 / 2893 / 2974 / 3035  
 Nominal Lumen (lm): 3928 / 4193 / 4310 / 4398  
 CRI: >90 CRI  
 Lamp Life (hrs): 50000  
 Upon Request: Special Color Temperature Special Led

#### OPTICAL

Reflector: 18 / 26 / 40  
 Adjustability: Rotational 340°; Tilt 90°  
 Upon Request: Special Beam Angles

#### RATINGS AND CERTIFICATIONS

Certified By: Certified for North American Standards  
 IP rating: IP20



## CENTRIQ 95 TRACK

A3T019-

|           |
|-----------|
| PROJECT   |
| TYPE      |
| SPECIFIER |
| QUANTITY  |
| DATE      |



A

|           |       |
|-----------|-------|
| PROJECT   | _____ |
| TYPE      | _____ |
| SPECIFIER | _____ |
| QUANTITY  | _____ |
| DATE      | _____ |

## CENTRIQ 95 TRACK

### A3T022-

|             |             |                   |                    |                     |                      |
|-------------|-------------|-------------------|--------------------|---------------------|----------------------|
| base number | LED Dimming | Color Temperature | Finishes (Diamond) | Finishes (Triangle) | Track Adapter Finish |
|-------------|-------------|-------------------|--------------------|---------------------|----------------------|

- To build a product code in our configurator select the specify button on the base model # product page
- To build a manual product code on this datasheet choose from the options listed below in blue font and add the suffix to the base model #

#### GENERAL

Series: Centriq  
 Subseries: Centriq 95  
 Brand: Prolicht  
 Division: Architectural  
 Mounting Type: Track  
 Mounting Location: Ceiling  
 Subcategory: Spots

#### PHYSICAL

Shape: Cylinder  
 Diameter (mm): 95  
 Diameter (in): 3 3/4  
 Length (mm): 235  
 Length (in): 9 1/4  
 Height (mm): 150  
 Height (in): 5 7/8  
 Light Distribution: Adjustable / Direct  
 Weight (kg): 1.4  
 Weight (lbs): 3.08  
 Fixture Finish: SSR / BKV / CWI / CRY / HAB / UFT / ITA / RUA / FTG / MYG / LOD / PUS / FRO / FUP / KIA / POP / BLS / SPG / MEY / GOH / GUM / CHC / COM / ABZ / JAG / OBR / MOS / ROR  
 Fixture Material: Aluminum

#### ELECTRICAL

Lamp Type: LED (Zhaga Standard)  
 Input Wattage (W): 12 / 15  
 Total Output Wattage (W): 10.8 / 13.5  
 Dimming: Tri-Mode (Non-Dimming and Phase Dimming (120Vac only) and 0-10V Dimming)  
 Driver Included: Yes  
 Driver Location: Integrated  
 Driver Type: Constant Current - Universal  
 Driver Class: Class 2  
 Input Voltage (V): 120 - 277  
 Constant Current (MA): 350

#### LED

Number of LEDs: 1  
 Color Temperature (°K): 2700 / 3000 / 3500 / 4000  
 Max. Delivered Lumen (lm): 830 / 930 / 1009 / 1030  
 Nominal Lumen (lm): 960 / 1070 / 1157 / 1180  
 CRI: >90 CRI  
 Lamp Life (hrs): 50000  
 Upon Request: Special Color Temperature Special Led

#### OPTICAL

Beam Angle: 8  
 Adjustability: Rotational 340°; Tilt 90°  
 Upon Request: Special Beam Angles

#### RATINGS AND CERTIFICATIONS

Certified By: Certified for North American Standards  
 IP rating: IP20



## CENTRIQ 95 TRACK

A3T022-

PROJECT

TYPE

SPECIFIER

QUANTITY

DATE

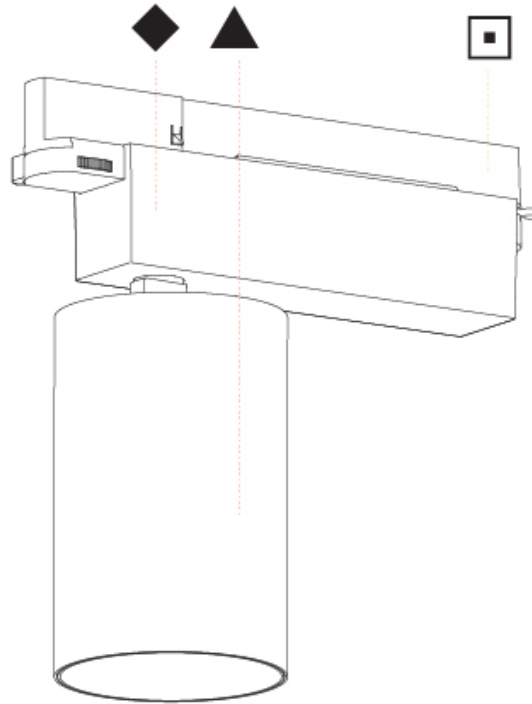

A



|           |
|-----------|
| PROJECT   |
| TYPE      |
| SPECIFIER |
| QUANTITY  |
| DATE      |

### Fixture Finish



**Digital:** Not all screens are calibrated the same, and therefore, colors will appear differently between screens.

**Physical:** When texture is involved, there will be variations in color, character and tone within a product series and between product families.

**Gun Metal:** No Gun Metal finish is alike. It combines a mixture of transparent and black color particles which ensures a highly individual effect and no luminaire being identical.

**Champagne Cream, Copper Mine, Ancient Bronze + Jazz Gold:** These finishes have slight fading from specific powder coating production. Each luminaire will slightly vary.













### LEGEND

|                                                                                    |                                                           |                                                                                     |                                                              |                                                                                       |                                                                                                |
|------------------------------------------------------------------------------------|-----------------------------------------------------------|-------------------------------------------------------------------------------------|--------------------------------------------------------------|---------------------------------------------------------------------------------------|------------------------------------------------------------------------------------------------|
|    | floor-mounted                                             |    | pivotal                                                      |    | special LED (upon request) RGB, RGBW, tunable, gold+, meat+, art+, fashion+                    |
|    | wall and ceiling: recessed and surface mounted            |    | rotating                                                     |    | warm dim / natural dimming LED                                                                 |
|    | ceiling-mounted and wall-mounted                          |    | illuminate tilted                                            |    | rechargeable battery powered                                                                   |
|    | wall-mounted                                              |    | color of suspension cable                                    |    | fixture with natural vivid LED (upon request)                                                  |
|    | omni-directional light distribution                       |    | length of suspension cable                                   |    | color rendering index                                                                          |
|    | direct light distribution                                 |    | reflector degree selection                                   |    | color temperature                                                                              |
|    | direct/indirect light distribution                        |    | super spot                                                   |    | lumen (luminous flux)                                                                          |
|    | indirect light distribution                               |    | lens                                                         |    | efficacy (lumens per watt)                                                                     |
|    | asymmetric light distribution                             |    | lens pack                                                    |    | Unified Glare Rating (UGR) range from 5-40                                                     |
|    | aura light distribution                                   |    | shine ring                                                   |    | marine grade (AISI 316 stainless steel)                                                        |
|    | round wall or ceiling cut-out                             |    | integrated shine ring with diffuser                          |    | walk on                                                                                        |
|    | square wall or ceiling cut-out                            |    | free individual colors 01-29                                 |    | drive on                                                                                       |
|    | the supplied jig specifies the cutout dimensions          |    | individual colors: 00 (free of charge), 01-25 (extra charge) |    | Dark Sky Compliance                                                                            |
|    | minimum distance (meters) lamp - object                   |    | luminaire part to be colored (F1)                            |    | Americans with Disabilities Act (less than 4" off the wall located between 27"-84" from floor) |
|    | recessed depth                                            |    | luminaire part to be colored (F2)                            |    | lamp protected against explosion                                                               |
|   | ceiling thickness in mm                                   |   | luminaire part to be colored (F3)                            |   | blown glass using traditional methods by master glass blower                                   |
|  | ceiling thickness selection                               |  | luminaire part to be colored (F4)                            |  | acoustic material                                                                              |
|  | dimmable DP (phase), DV (0-10V), DD (dali), DS (step-dim) |  | luminaire part to be colored (F5)                            |  | protection class I, protection insulation                                                      |
|  | included or excluded LED driver/transformer/control gear  |  | color of 3-circuit adaptor                                   |  | protection class II, protection insulation                                                     |
|  | separately switchable                                     |  | indirect diffuser                                            |  | ETL Certified to UL and CSA Standards                                                          |
|  | sensor                                                    |  | direct diffuser                                              |  | UL Certified to UL and CSA Standards                                                           |
|  | remote control                                            |  | ball-proof (upon request)                                    |  | CSA Certified to UL and CSA Standards                                                          |
|  | available upon request                                    |  | accessory                                                    |  | Certified for North American Standards                                                         |

### IP RATING

|                                                                                   |                                                                                                                                                  |
|-----------------------------------------------------------------------------------|--------------------------------------------------------------------------------------------------------------------------------------------------|
|  | protected against ingress of solid bodies greater than 12.5mm (finger)                                                                           |
|  | protected against ingress of solid bodies greater than 2.5mm<br>protected against sprays of water up to 60 degrees from the vertical (rain)      |
|  | protected against ingress of solid bodies greater than 1mm (wire)<br>no protection against the ingress of moisture                               |
|  | protected against ingress of solid bodies greater than 1mm (wire)<br>protected against sprays of water up to 60 degrees from the vertical (rain) |
|  | protected against ingress of solid bodies greater than 1mm (wire)<br>protected against water splashed from all directions                        |
|  | protected against limited ingress of dust (wet rooms/covered outdoor areas)<br>protected against water splashed from all directions              |
|  | protected against ingress of dust<br>protected against jets of water                                                                             |
|  | protected against ingress of dust<br>protected against powerful jets of water or heavy seas                                                      |
|  | protected against ingress of dust<br>protected against immersion of water between 15cm - 1m for 30 minutes                                       |
|  | protected against ingress of dust<br>protected against immersion of water under pressure for long periods                                        |

### IK RATING

|                                                                                     |                                                                                                       |
|-------------------------------------------------------------------------------------|-------------------------------------------------------------------------------------------------------|
|  | protected against 0.14 joules impact (equivalent to 0.25kg mass dropped from 56mm above the surface)  |
|  | protected against 0.2 joules impact (equivalent to 0.25kg mass dropped from 80mm above the surface)   |
|  | protected against 0.35 joules impact (equivalent to 0.25kg mass dropped from 140mm above the surface) |
|  | protected against 0.5 joules impact (equivalent to 0.25kg mass dropped from 200mm above the surface)  |
|  | protected against 0.7 joules impact (equivalent to 0.25kg mass dropped from 280mm above the surface)  |
|  | protected against 1 joules impact (equivalent to 0.25kg mass dropped from 400mm above the surface)    |
|  | protected against 2 joules impact (equivalent to 0.5kg mass dropped from 400mm above the surface)     |
|  | protected against 5 joules impact (equivalent to 1.7kg mass dropped from 300mm above the surface)     |
|  | protected against 10 joules impact (equivalent to 5.0kg mass dropped from 200mm above the surface)    |
|  | protected against 20 joules impact (equivalent to 5.0kg mass dropped from 400mm above the surface)    |